

TV/VCR TUNER IC WITH DC/DC CONVERTER

FEATURES

- Single Chip Mixer/Oscillator, Synthesizer, and 30-V DC/DC Converter for Tuning Amplifier
- VHF-L, VHF-H, UHF 3-Band Local Oscillator
- I²C Bus Protocol
- Four Data Bytes Transmission
- Low Noise DC/DC Converter
- 4ch NPN Emitter Follower Type Band Switch Drivers
- 4ch NPN Open Collector Type Ports
- Programmable Reference Divider Ratio (31.25 kHz, 50 kHz, or 62 kHz)
- 5-V Power Supply
- 38-Pin TSSOP Package

DESCRIPTION

The SN761677 is a single-chip synthesized tuner IC designed for TV/VCR tuning systems. The circuit consists of a PLL synthesizer, 3-band local oscillators and mixer, 30-V dc/dc converter for tuning the amplifier, four NPN emitter follower band drivers, four NPN open collector ports, and is available in a small package outline. The 15-bit programmable counter and reference divider are controlled by I²C bus control. Tuning step frequency is selectable by the reference divider ratio for a 4-MHz Xtal oscillator.

DA PACKAGE (TOP VIEW)
38-PIN TSSOP (DA)

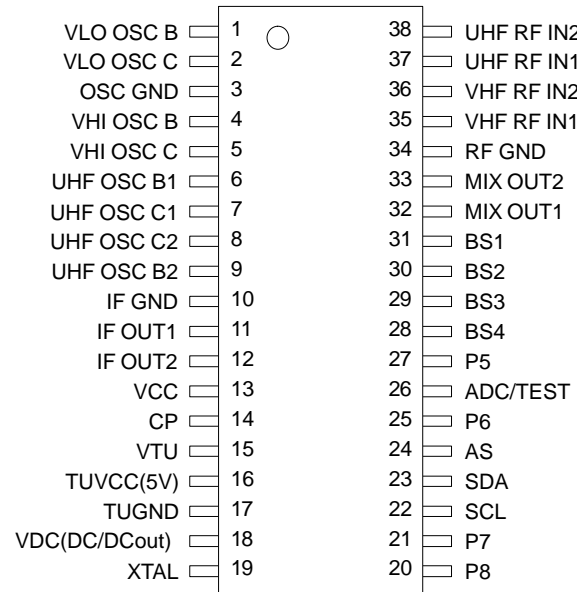

Please be aware that an important notice concerning availability, standard warranty, and use in critical applications of Texas Instruments semiconductor products and disclaimers thereto appears at the end of this data sheet.



These devices have limited built-in ESD protection. The leads should be shorted together or the device placed in conductive foam during storage or handling to prevent electrostatic damage to the MOS gates.

ABSOLUTE MAXIMUM RATINGS

over operating free-air temperature range unless otherwise noted⁽¹⁾

		UNIT
Supply voltage ⁽²⁾ , V _{CC}	VCC, TUVCC	-0.4 V to 7 V
Input voltage 1 ⁽²⁾ , V _{GND}	RF GND, OSC GND, TUGND	-0.4 V to 0.4 V
Input voltage 2 ⁽²⁾ , V(VTU)	VTU ⁽⁴⁾	-0.4 V to 35 V
Input voltage 3 ⁽²⁾ , V _{IN}	Other input pins	-0.4 V to 7 V
Continuous total dissipation ⁽³⁾ , P _D	T _A ≤ 25°C	1168 mW
Operating free-air temperature, T _A		-20°C to 85°C
Storage temperature range, T _{stg}		-65°C to 150°C
Maximum junction temperature, T _J		150°C
Maximum lead temperature 1,6 mm (1/16 inch) from case for 10 seconds		260°C
Maximum short circuit time, t _{SC(max)}	All pins to VCC/TUVCC, IFGND, OSCGND, RFGND, TUGND	10 sec

(1) Stresses beyond those listed under “absolute maximum ratings” may cause permanent damage to the device. These are stress ratings only, and functional operation of the device at these or any other conditions beyond those indicated under “recommended operating conditions” is not implied. Exposure to absolute-maximum-rated conditions for extended periods may affect device reliability.

(2) Voltage values are with respect to the IF GND of the circuit.

(3) Derating factor is 9.34 mW/°C for T_A ≤ 25°C.

(4) 30 V max, when input from external power supply.

RECOMMENDED OPERATING CONDITIONS

		MIN	NOM	MAX	UNIT
Supply voltage, V _{CC}		4.5	5	5.5	V
Band switch driver source current, I _{BS}	One port on			10	mA
NPN port sink current, I _{NPN}	One port on		-10	-15	mA
Operating free-air temperature, T _A		-20		85	°C

CAUTION:

It is advised that precautions be taken to avoid damage due to high static voltages or electrostatic fields while handling this device. UHF OSC (pins 6–9) can withstand 1.5 kV and all other pins can withstand 2 kV, according to the Human Body Model (1.5 kΩ, 100 pF).

ELECTRICAL CHARACTERISTICS
 $V_{CC} = 4.5\text{ V to }5.5\text{ V}$, $T_A = -20^\circ\text{C to }85^\circ\text{C}$ (unless otherwise noted)⁽¹⁾

PARAMETER		TEST CONDITIONS	MIN	TYP	MAX	UNIT
Total Device and Serial Interface						
I_{CC1}	Supply current 1 (VCC)			75	95	mA
I_{CC2}	Supply current 2 (VCC)	One band switch on ($I_{BS} = 10\text{ mA}$)		85	105	mA
I_{CC3}	Supply current 3 (TUVCC)	$I_{VDC} = 50\text{ }\mu\text{A}$		4	10	mA
V_{IH}	High-level input voltage (SCL, SDA)		3			V
V_{IL}	Low-level input voltage (SCL, SDA)				1.5	V
I_{IH}	High-level input current (SCL, SDA)				10	μA
I_{IL}	Low-level input current (SCL, SDA)		-10			μA
V_{POR}	Power-on reset supply voltage	Threshold of supply voltage between reset and operation mode	2.1	3.7	4	V
DC/DC Converter						
$V_{O(VDC)}$	Output voltage (VDC)	$I_{VDC} = 50\text{ }\mu\text{A}$		35		V
$I_{C(VDCM)}$	Output current (VDC)			230		μA
t_s	Output settling time (VDC)	From $V_{TUVCC} > 4.5\text{ V}$ to $V_{O(VDC)} < 28\text{ V}$		100		ms
I²C Interface						
V_{ASH}	Address select high-input voltage (AS)	$V_{CC} = 5\text{ V}$	4.5		5	V
V_{ASM}	Address select mid-input voltage (AS)	$V_{CC} = 5\text{ V}$	2		3	V
V_{ASL}	Address select low-input voltage (AS)	$V_{CC} = 5\text{ V}$			0.5	V
I_{ASH}	Address select high-input current (AS)				10	μA
I_{ASL}	Address select low-input current (AS)		-10			μA
$V_{I(ADC)}$	ADC input voltage	See Table 9	0		V_{CC}	V
$I_{IH(ADH)}$	ADC high-level input current	$V_{I(ADC)} = V_{CC}$			10	μA
$I_{IL(ADL)}$	ADC low-level input current	$V_{I(ADC)} = 0\text{ V}$	-10			μA
V_{OL}	Low-level output voltage (SDA)	$V_{CC} = 5\text{ V}$, $I_{OL} = 3\text{ mA}$			0.4	V
$I_{lkg(SDA)}$	High-level output leakage current (SDA)	$V_{SDA} = 5.5\text{ V}$			10	μA
F_{SCL}	Clock frequency (SCL)			100	400	kHz
$t_h(\text{DAT})$	Data hold time	See timing chart in Figure 1	0			μs
t_{BUF}	Bus free time		1.3			μs
$t_h(\text{STA})$	Start hold time		0.6			μs
$t_h(\text{low})$	SCL low hold time		0.6			μs
$t_h(\text{high})$	SCL high hold time		0.6			μs
$t_{su}(\text{STA})$	Start setup time		0.6			μs
$t_{su}(\text{DAT})$	Data setup time		0.1			μs
t_r	SCL, SDA rise time				0.3	μs
t_f	SCL, SDA fall time				0.3	μs
$t_{su}(\text{STO})$	STOP setup time		0.6			μs

ELECTRICAL CHARACTERISTICS (Continued)
 $V_{CC} = 4.5\text{ V to }5.5\text{ V}$, $T_A = -20^\circ\text{C to }85^\circ\text{C}$ (unless otherwise noted)⁽¹⁾

PARAMETER		TEST CONDITIONS	MIN	TYP	MAX	UNIT
PLL and NPN Port						
N	Divider ratio	14-bit frequent word	256		16383	
		15-bit frequent word	256		32767	
FXTAL	Crystal oscillator	Rxtal = 25 Ω to 300 Ω		4		MHz
ZXTAL	Crystal oscillator input impedance	$V_{CC} = 5\text{ V}$, $T_A = 25^\circ\text{C}$		2.3		k Ω
VXTALIN	External crystal oscillator input amplitude		400			mV _{p-p}
V _{O(TU)}	Tuning amplifier low-level output voltage	$R_L = 27\text{ k}\Omega$		0.4	0.7	V
I _{IH(CPH)}	Charge pump high-level input current	CP = 1		40		μA
I _{IL(CPH)}	Charge pump low-level input current	CP = 0		10		μA
V _{O(CP)}	Charge pump output voltage	In lock		1.95		V
I _{Ikg(CPOFF)}	Charge pump leakage current	T2 = 0, T1 = 1, V _{O(CP)} = 2 V, T _A = 25°C	-15		15	nA
I _{BS}	Band switch driver source current				10	mA
V _{O(SBS1)}	Band switch driver output voltage	I _{BS} = 10 mA	3			V
V _{O(SBS2)}		I _{BS} = 10 mA, V _{CC} = 5 V, T _A = 25°C	3.5	3.9		V
I _{Ikg(BSOFF)}	Band switch driver leakage current	V _{BS} = 0 V			3	μA
I _{NPN}	NPN port sink current				-15	mA
V _{O(SN1)}	NPN port output voltage	I _{NPN} = 100 μA			0.2	V
V _{O(SN2)}		I _{NPN} = 10 mA			0.5	V
I _{Ikg(NPNOFF)}	NPN port leakage current	V _{CC} = 5.5 V, V _{NPN} = 1.5 V			1	μA

ELECTRICAL CHARACTERISTICS

$V_{CC} = 5\text{ V}$, $T_A = -25^\circ\text{C}$, measured in reference measurement circuit at 50- Ω system, IF filter characteristics: $f_{\text{peak}} = 43\text{ MHz}$; (unless otherwise noted)⁽¹⁾

PARAMETER		CONDITION	MIN	TYP	MAX	UNIT
MIXER, OSCILLATOR, IF AMPLIFIER						
G_{c1}	Conversion gain (mixer-IF amplifier) VHF low	$F_{in} = 58\text{ MHz}^{(1)}$	23	26	29	dB
G_{c3}		$F_{in} = 130\text{ MHz}$				
G_{c4}	Conversion gain (mixer-IF amplifier) VHF high	$F_{in} = 136\text{ MHz}^{(1)}$	23	26	29	dB
G_{c6}		$F_{in} = 364\text{ MHz}$				
G_{c7}	Conversion gain (mixer-IF amplifier) VHF-UHF	$F_{in} = 370\text{ MHz}^{(1)}$	24	27	30	dB
G_{c9}		$F_{in} = 804\text{ MHz}$				
NF_1	Noise figure VHF low	$F_{in} = 55.25\text{ MHz}$		11		dB
NF_3		$F_{in} = 127.25\text{ MHz}$				
NF_4	Noise figure VHF high	$F_{in} = 133.25\text{ MHz}$		11		dB
NF_6		$F_{in} = 361.25\text{ MHz}$				
NF_7	Noise figure UHF	$F_{in} = 367.25\text{ MHz}$		10		dB
NF_9		$F_{in} = 801.25\text{ MHz}$				
CM_1	1% cross modulation distortion VHF low	$F_{in} = 55.25\text{ MHz}^{(2)}$		89		dB μ V
CM_3		$F_{in} = 127.25\text{ MHz}$				
CM_4	1% cross modulation distortion VHF high	$F_{in} = 133.25\text{ MHz}^{(2)}$		86		dB μ V
CM_6		$F_{in} = 361.25\text{ MHz}$				
CM_7	1% cross modulation distortion UHF	$F_{in} = 367.25\text{ MHz}^{(2)}$		87		dB μ V
CM_9		$F_{in} = 801.25\text{ MHz}$				
$V_{O(IF1)}$	IF output voltage VHF low	$F_{in} = 55.25\text{ MHz}^{(3)}$		117		dB μ V
$V_{O(IF3)}$		$F_{in} = 127.25\text{ MHz}$				
$V_{O(IF4)}$	IF output voltage VHF high	$F_{in} = 133.25\text{ MHz}^{(3)}$		117		dB μ V
$V_{O(IF6)}$		$F_{in} = 361.25\text{ MHz}$				
$V_{O(IF7)}$	IF output voltage UHF	$F_{in} = 367.25\text{ MHz}^{(3)}$		117		dB μ V
$V_{O(IF9)}$		$F_{in} = 801.25\text{ MHz}$				

(1) IF = 43 MHz, RF input level = 80 dB μ V

(2) $F_{undes} = F_{des} \pm 6\text{ MHz}$, $p_{in} = 80\text{ dB}\mu\text{V}$, AM 1 kHz, 30%, DES/CM = S/I = 46 dB

(3) IF = 45.75 MHz_{top}

BLOCK DIAGRAM

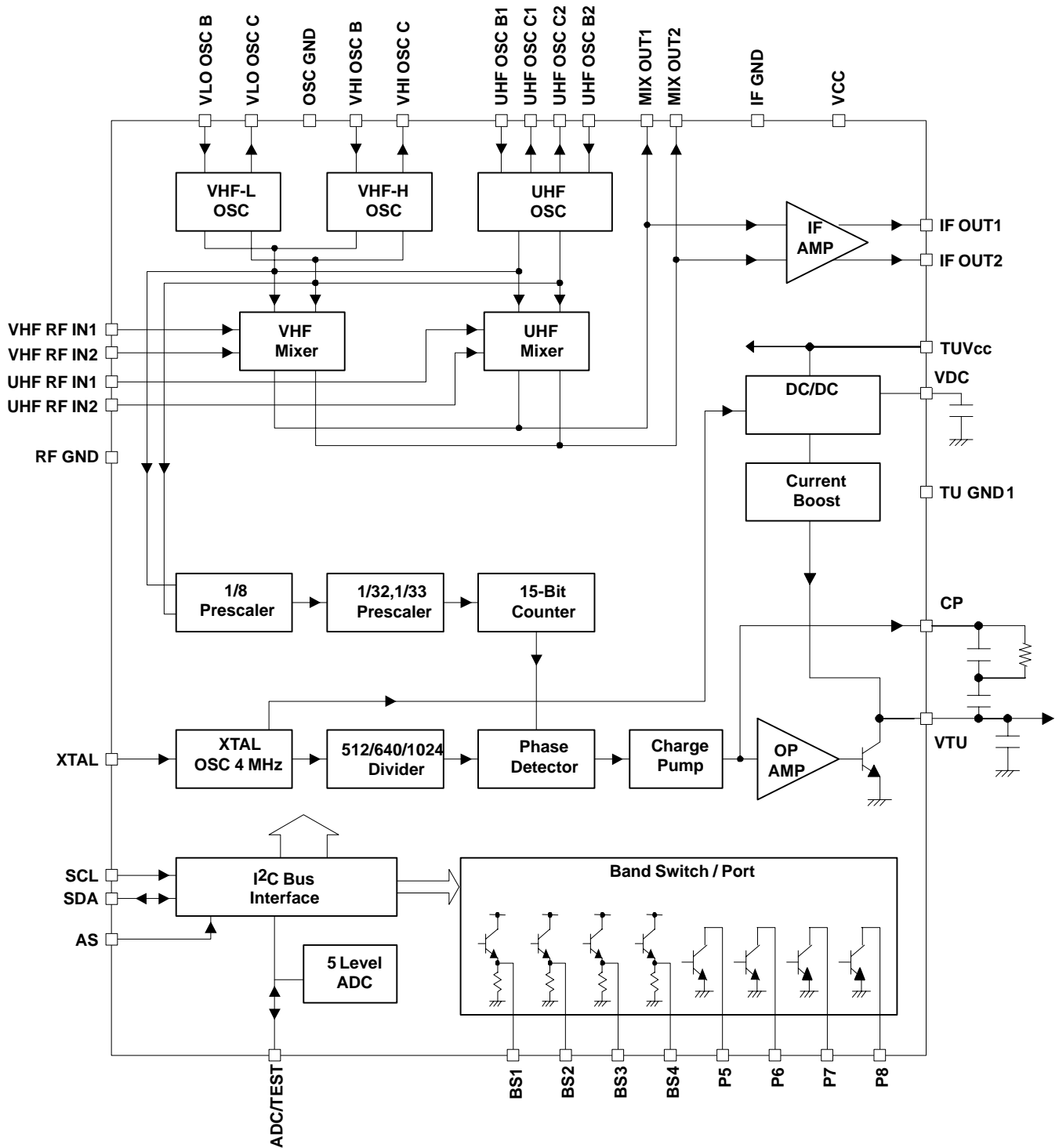

Terminal Functions

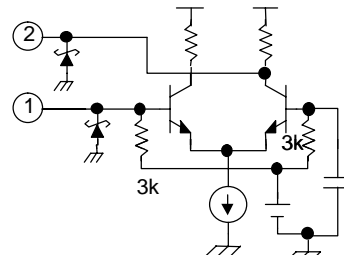
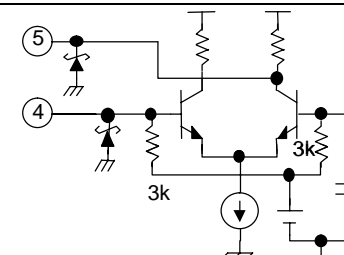
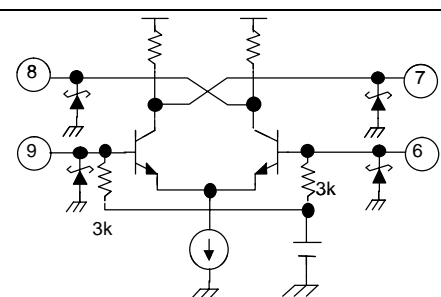
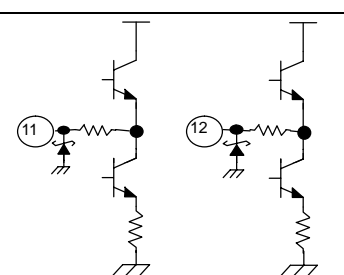
TERMINAL		DESCRIPTION	
NAME	NO.		
VLO OSC B	1	VHF low oscillator input base	
VLO OSC C	2	VHF low oscillator output collector	
OSC GND	3	Oscillator ground	
VHI OSC B	4	VHF hi oscillator input base	
VHI OSC C	5	VHF hi oscillator output collector	
UHF OSC B1	6	UHF oscillator input base1	
UHF OSC C1	7	UHF oscillator output collector1	
UHF OSC C2	8	UHF oscillator output collector2	
UHF OSC B2	9	UHF oscillator input base2	
IF GND	10	IF ground	
IF OUT1	11	IF output	
IF OUT2	12	IF output	
VCC	13	Supply voltage for mixer/oscillator/PLL: 5 V	

TERMINAL		DESCRIPTION	
NAME	NO.		
CP	14	Charge pump output	
VTU	15	Tuning voltage amplifier output	
TUVCC	16	Supply voltage for DC/DC converter: 5 V	
TUGND	17	DC/DC converter ground	
VDC	18	DC/DC converter monitor output. (Do not connect to other terminals or circuits except for the capacitor.)	
XTAL	19	4-MHz crystal oscillator input	
P8	20	Port 8 output (NPN open collector)	
P7	21	Port 7 output (NPN open collector)	
P6	25	Port 6 output (NPN open collector)	
P5	27	Port 5 output (NPN open collector)	
SCL	22	I ² C serial clock input	
SDA	23	I ² C serial data input/output	
AS	24	I ² C address set input	
ADC/TEST	26	ADC input / test output	

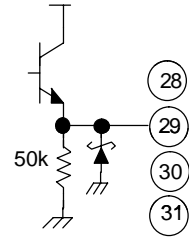
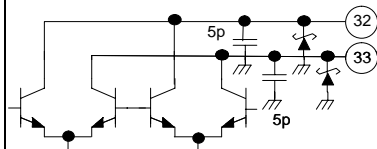
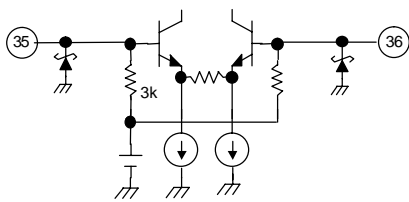
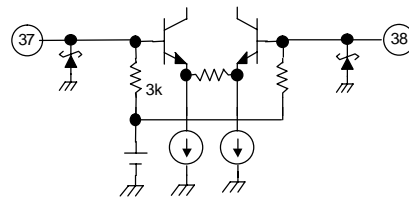
TERMINAL		DESCRIPTION	
NAME	NO.		
BS4	28	Band switch4 output (NPN emitter follower)	
BS3	29	Band switch3 output (NPN emitter follower)	
BS2	30	Band switch2 output (NPN emitter follower)	
BS1	31	Band switch1 output (NPN emitter follower)	
MIX OUT1	32	Mixer output	
MIX OUT2	33	Mixer output	
RF GND	34	RF ground	
VHF RF IN1	35	VHF RF input	
VHF RF IN2	36	VHF RF input	
UHF RF IN1	37	UHF RF input	
UHF RF IN2	38	UHF RF input	

FUNCTION DESCRIPTION

The device can be controlled according to the I²C bus format.

Table 1. Serial Interface Function

PIN	PIN NAME	DESCRIPTION
22	SCL	Clock input
23	SDA	Data input/output
24	AS	Address selection input
26	ADC/TEST	ADC input, test output

I²C Write Mode (R/W = 0)

Table 2. Write Data Format

	MSB							LSB	
Address byte (ADB)	1	1	0	0	0	MA1	MA0	R/W=0	A
Divider byte 1 (DB1)	0	N14	N13	N12	N11	N10	N9	N8	A
Divider byte 2 (DB2)	N7	N6	N5	N4	N3	N2	N1	N0	A
Control byte (CB)	1	CP	T2	T1	T0	RSA	RSB	OS	A
Ports byte (PB)	P8	P7	P6	P5	BS4	BS3	BS2	BS1	A

Table 3. Description of Data Symbol

SYMBOL	DESCRIPTION	DEFAULT																
MA1, MA0	Address set bits (See Table 4)																	
N14...N0	Programmable counter set bits N=N14x2 ¹⁴ +N13x2 ¹³ +...+N1x2+N0	Nn=0																
CP	Charge pump current set bit 10 μA (CP=0) 40 μA (CP=1)	CP=1																
T2, T1, T0	Test bits (See Table 5) Normal mode: T2=0, T1=0, T0=1/0	T2=0, T1=0, T0=0																
RSA, RSB	Reference divider ratio selection bits (See Table 6)	RSA=0, RSB=1																
OS	Tuning amplifier control bit Tuning voltage ON (OS=0) Tuning voltage OFF, high impedance (OS=1)	OS=0																
BS4...BS1	Band switch ports control bits BSn=0:Tr=OFF BSn=1:Tr=ON Band selection by BS1, 2, 4 (x: don't care) <table border="1" style="margin-left: 40px;"> <thead> <tr> <th></th> <th>BS1</th> <th>BS2</th> <th>BS4</th> </tr> </thead> <tbody> <tr> <td>VHF–Lo</td> <td>1</td> <td>0</td> <td>0</td> </tr> <tr> <td>VHF–Hi</td> <td>x</td> <td>1</td> <td>0</td> </tr> <tr> <td>UHF</td> <td>x</td> <td>x</td> <td>1</td> </tr> </tbody> </table>		BS1	BS2	BS4	VHF–Lo	1	0	0	VHF–Hi	x	1	0	UHF	x	x	1	BSn=0
	BS1	BS2	BS4															
VHF–Lo	1	0	0															
VHF–Hi	x	1	0															
UHF	x	x	1															
P8...P5	NPN open collector ports control bits Pn=0: Tr=OFF Pn=1: Tr=ON	Pn=0																
X	Don't care																	

NOTE: A: Acknowledge

Table 4. Address Selection

VOLTAGE APPLIED ON AS INPUT	MA1	MA0
0 V to 0.1 V _{CC}	0	0
Always valid	0	1
0.4 V _{CC} to 0.6 V _{CC}	1	0
0.9 V _{CC} to V _{CC}	1	1

Table 5. Test Bits

T2	T1	T0	FUNCTION	
0	0	0	Normal operation	Default
0	0	1	Normal operation	
0	1	X	Charge pump off	
1	1	0	Charge pump sink	
1	1	1	Charge pump source	
1	0	X	Test mode	Not available ADC

Table 6. Ratio Select Bits

RSA	RSB	REFERENCE DIVIDER RATIO
X	0	640
0	1	1024
1	1	512

I²C Read Mode (R/W = 1)

Table 7. Read Data Format

	MSB							LSB	
Address byte (ADB)	1	1	0	0	0	MA1	MA0	R/W=1	A
Status byte (SB)	POR	FL	1	1	1	A2	A1	A0	A

NOTE: A: Acknowledge

Table 8. Description of Data Symbol

SYMBOL	DESCRIPTION	DEFAULT
MA1, MA0	Address set bits (see Table 4)	
POR	Power-on reset flag POR Set: Power on POR Reset: End-of-data transmission procedure	POR=1
FL	In-lock flag PLL lock (FL=1) Unlock (FL=0)	
A2...A0	Digital data of ADC (see Table 9)	

Table 9. ADC Level

VOLTAGE APPLIED ON ADC INPUT	A2	A1	A0
0.6 V _{CC} to V _{CC}	1	0	0
0.45 V _{CC} to 0.6 V _{CC}	0	1	1
0.3 V _{CC} to 0.45 V _{CC}	0	1	0
0.15 V _{CC} to 0.3 V _{CC}	0	0	1
0 V _{CC} to 0.15 V _{CC}	0	0	0

(1) Accuracy is 0.03 x V_{CC}.

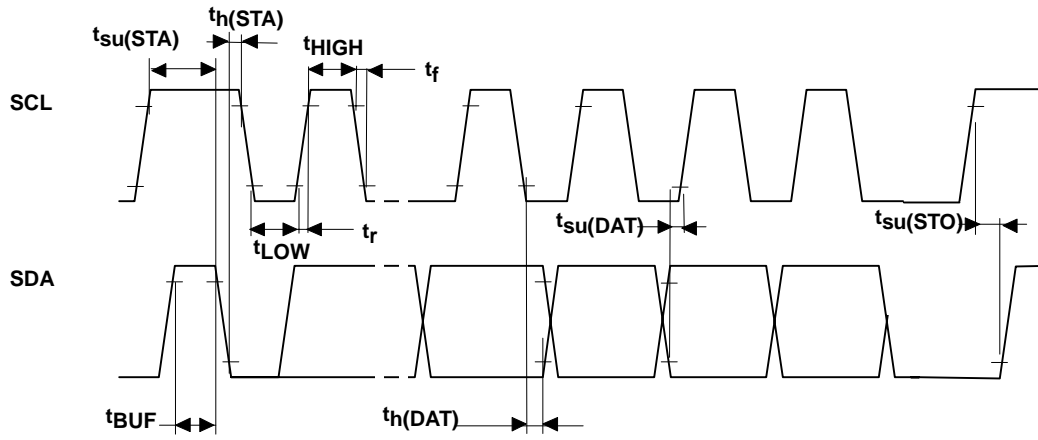
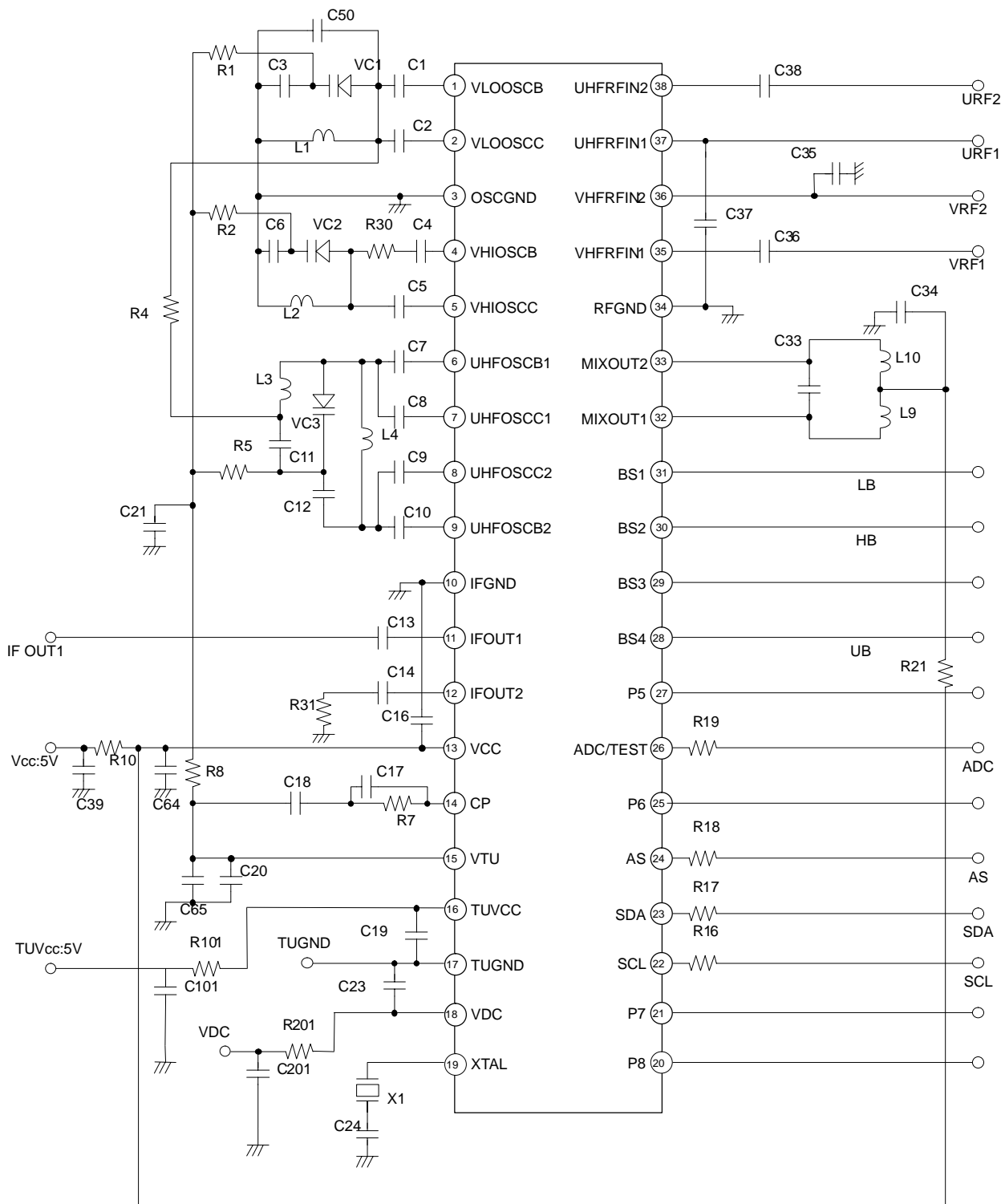

Figure 1. I²C Timing Chart

APPLICATION INFORMATION



(1) It is recommended that designers be careful with the PCB layout and coupling to minimize the effects of the higher harmonics of Xtal oscillation from the dc/dc converter section (pin 16–20) to mixer and oscillator section.

Figure 2. Reference Measurement Circuit

COMPONENT VALUES FOR MEASUREMENT CIRCUIT (TENTATIVE)

PART NAME	VALUE
C1, C2, C4	1 pF
C3	47 pF
C5	1.5 pF
C6	56 pF
C7–C10	1 pF (axial ceramic)
C11	100 pF
C12	13 pF (axial ceramic)
C13, C14, C16, C17, C19–C21, C34–C39, C64, C101	2.2 nF
C18, C23	0.047 μ F
C24	68 pF
C33	18 pF
C41, C60, C62, C201	Not mounted
C50	3 pF
R1, R2, R4, R5, R8	33 k Ω
R7	100 k Ω
R10, R21, R101, R201	0 Ω
R16–R19	330 Ω
R30	20 Ω
R31	50 Ω
L1	2.6 ϕ , 8T, wire 0,3 mm
L2	2.4 ϕ , 4T, wire 0,4 mm
L3	2.8 ϕ , 2T, wire 0,4 mm
L4	2.1 ϕ , 3T, wire 0,4 mm
L9, L10	2.5 ϕ , 16T, wire 0,25 mm
VC1, VC2, VC3	1T363A
X1	4 MHz

TEST CIRCUIT

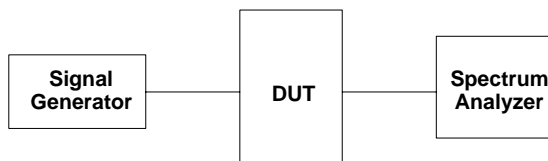

Figure 3. Measurement Circuit of Conversion Gain

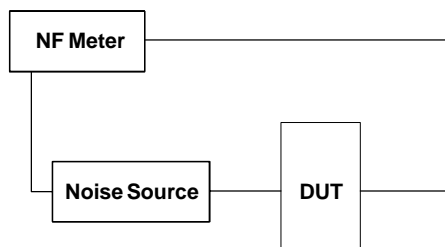

Figure 4. Noise Figure Measurement Circuit

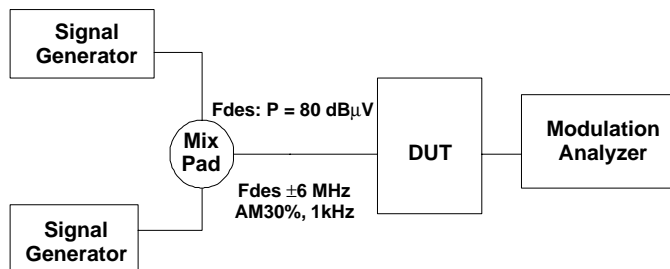

Figure 5. 1% Cross Modulation Distortion Measurement Circuit

S-PARAMETER

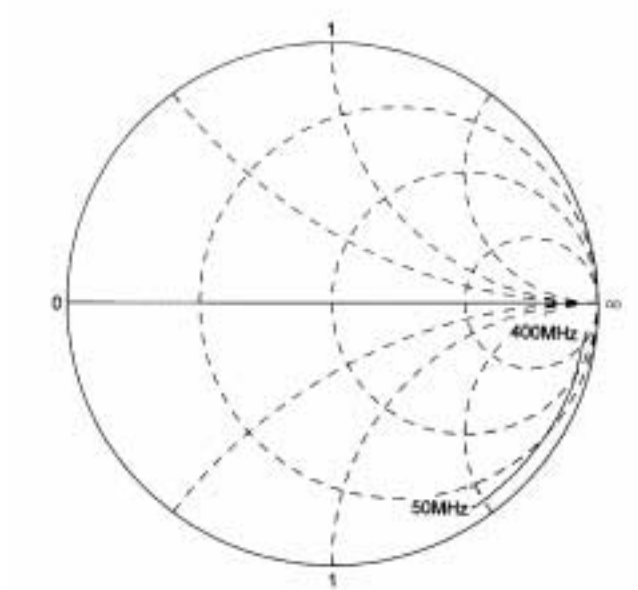

Figure 6. VHF Input

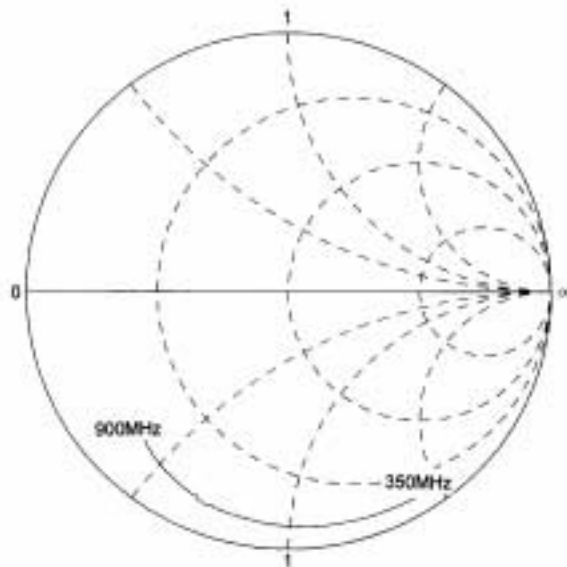

Figure 7. UHF Input

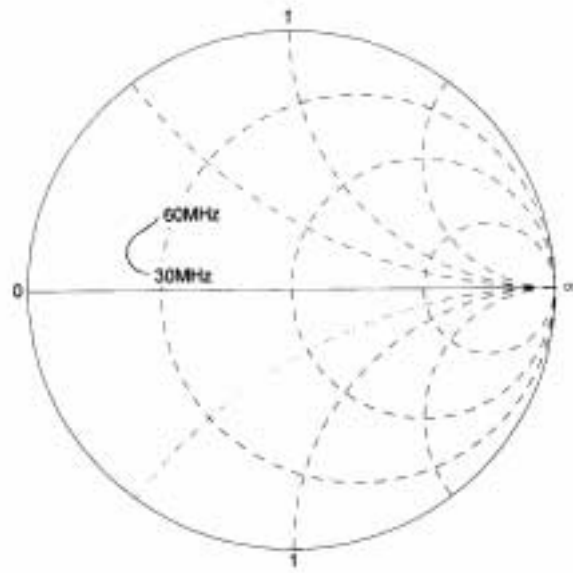

Figure 8. IF Output

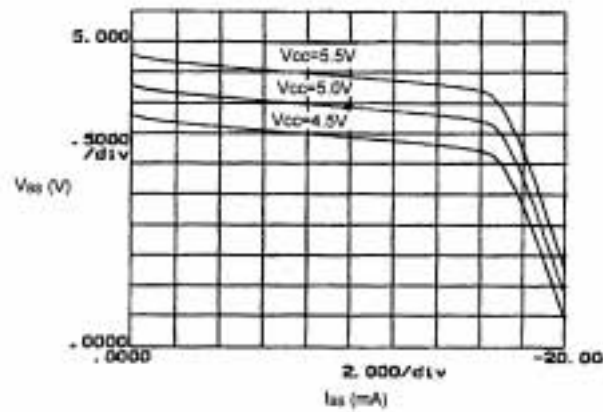

Figure 9. Band Switch Driver Output Voltage (BS1–BS4)

MECHANICAL DATA

DA (R-PDSO-G**)

PLASTIC SMALL-OUTLINE

38 PINS SHOWN

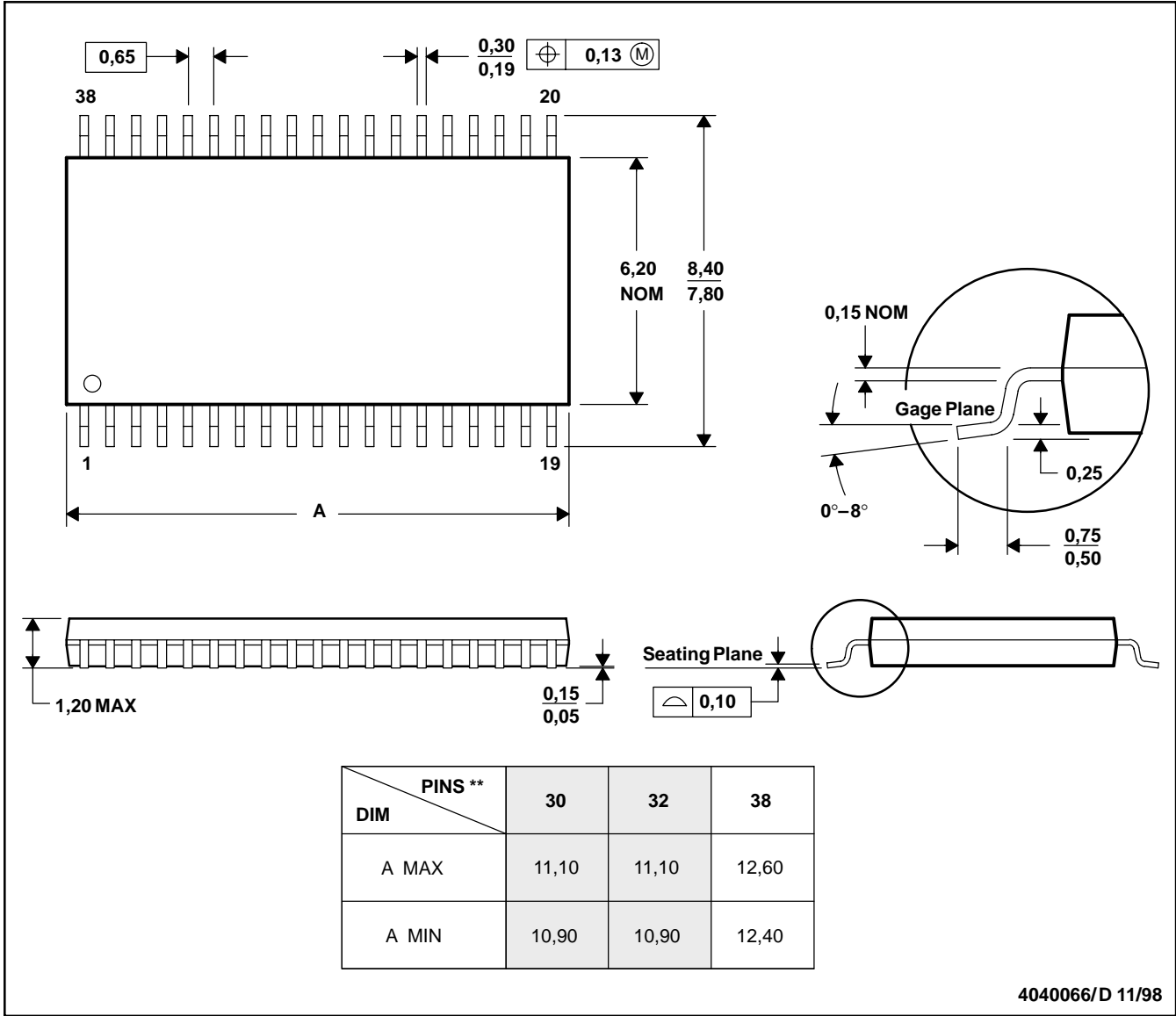

4040066/D 11/98

- NOTES: A. All linear dimensions are in millimeters.
 B. This drawing is subject to change without notice.
 C. Body dimensions do not include mold flash or protrusion.
 D. Falls within JEDEC MO-153

IMPORTANT NOTICE

Texas Instruments Incorporated and its subsidiaries (TI) reserve the right to make corrections, modifications, enhancements, improvements, and other changes to its products and services at any time and to discontinue any product or service without notice. Customers should obtain the latest relevant information before placing orders and should verify that such information is current and complete. All products are sold subject to TI's terms and conditions of sale supplied at the time of order acknowledgment.

TI warrants performance of its hardware products to the specifications applicable at the time of sale in accordance with TI's standard warranty. Testing and other quality control techniques are used to the extent TI deems necessary to support this warranty. Except where mandated by government requirements, testing of all parameters of each product is not necessarily performed.

TI assumes no liability for applications assistance or customer product design. Customers are responsible for their products and applications using TI components. To minimize the risks associated with customer products and applications, customers should provide adequate design and operating safeguards.

TI does not warrant or represent that any license, either express or implied, is granted under any TI patent right, copyright, mask work right, or other TI intellectual property right relating to any combination, machine, or process in which TI products or services are used. Information published by TI regarding third-party products or services does not constitute a license from TI to use such products or services or a warranty or endorsement thereof. Use of such information may require a license from a third party under the patents or other intellectual property of the third party, or a license from TI under the patents or other intellectual property of TI.

Reproduction of information in TI data books or data sheets is permissible only if reproduction is without alteration and is accompanied by all associated warranties, conditions, limitations, and notices. Reproduction of this information with alteration is an unfair and deceptive business practice. TI is not responsible or liable for such altered documentation.

Resale of TI products or services with statements different from or beyond the parameters stated by TI for that product or service voids all express and any implied warranties for the associated TI product or service and is an unfair and deceptive business practice. TI is not responsible or liable for any such statements.

Mailing Address:

Texas Instruments
Post Office Box 655303
Dallas, Texas 75265

This datasheet has been download from:

www.datasheetcatalog.com

Datasheets for electronics components.